

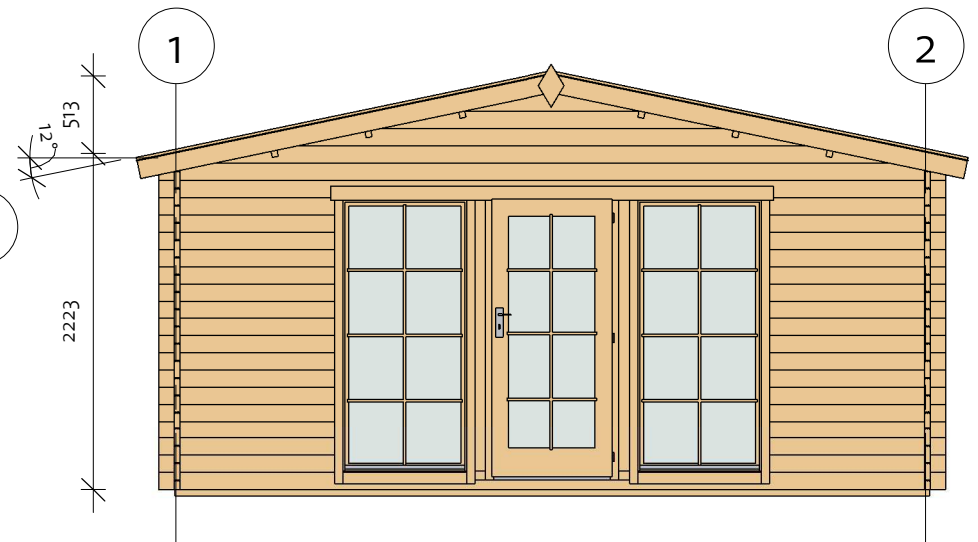

Luna 3 40 (552x500)

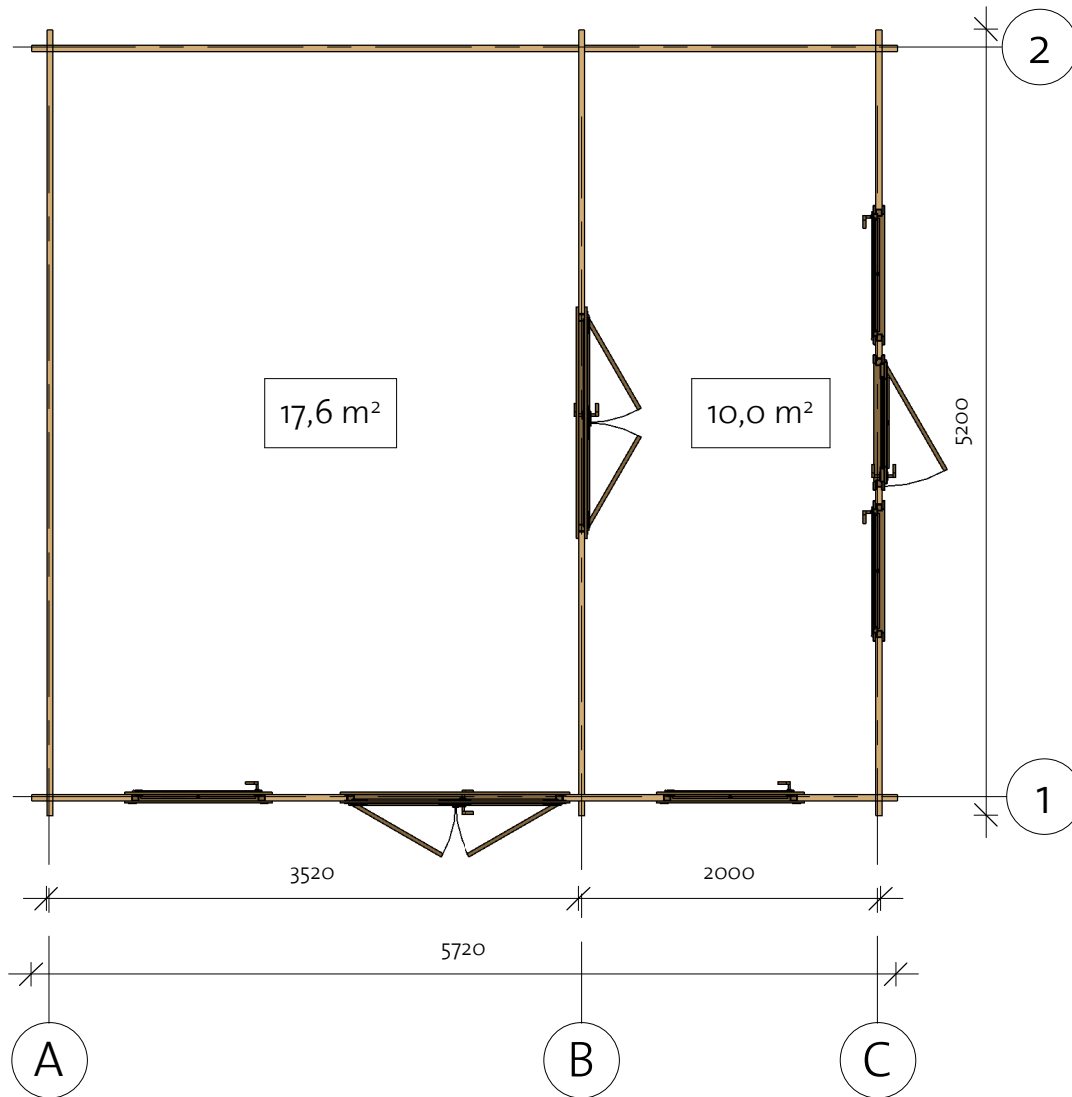
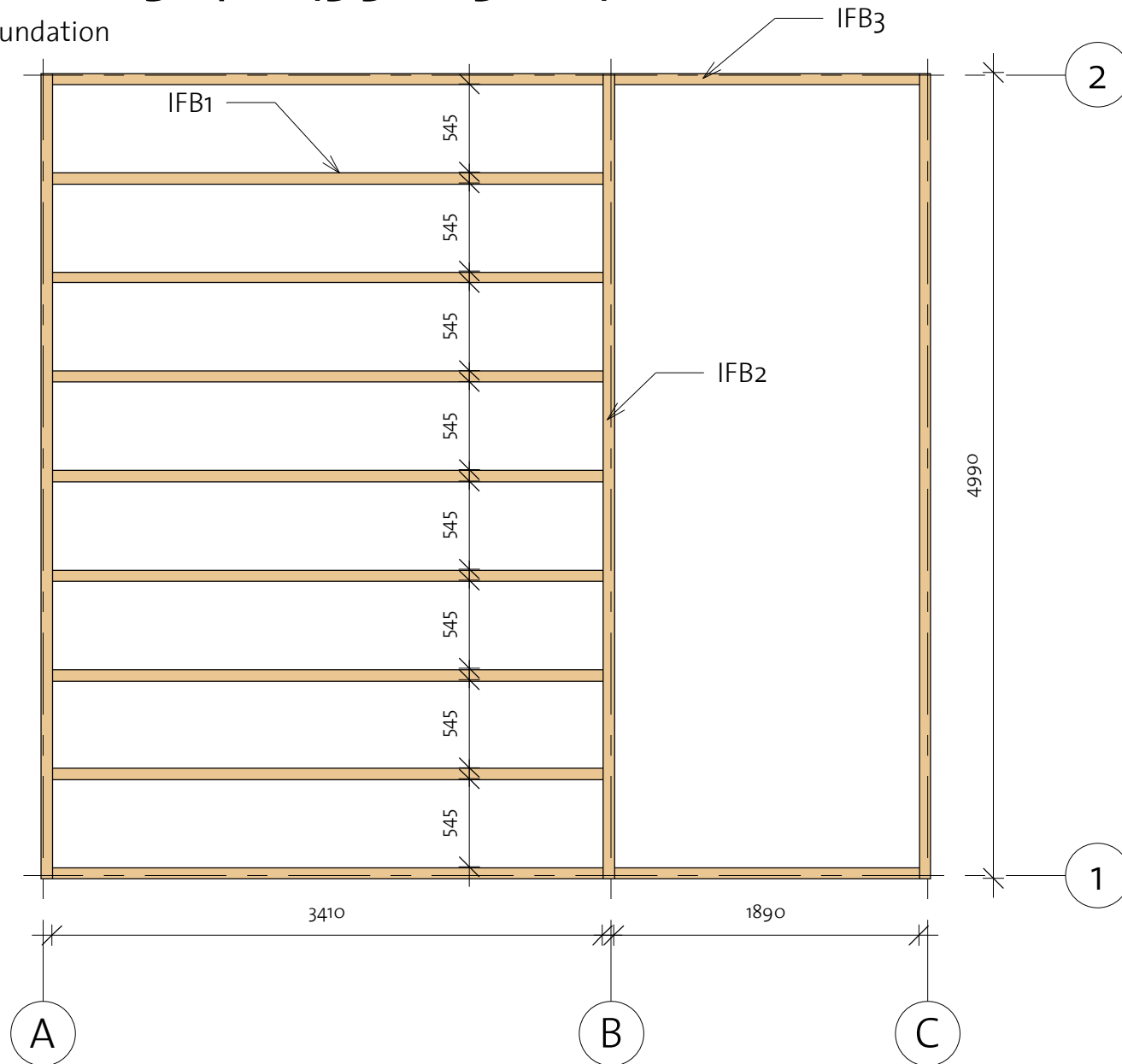

Luna 3 40 (552x500)

Foundation



Impregnated foundation beams				
Mark	Type	Profile	Count	Length
IFB1	IFB 70x40		9	3410
IFB2	IFB 70x40		3	4990
IFB3	IFB 70x40		2	1890

Luna 3 40 (552x500)

Floor Plan

① Baseboard

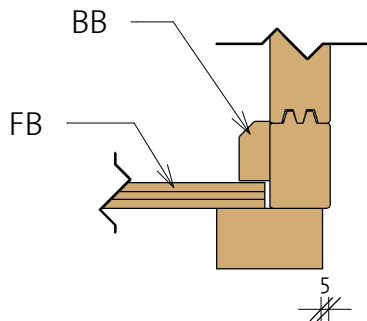

Floor Schedule				
Mark	Type	Profile	Count	Length

FB	FB 17x114		32	4914
----	-----------	--	----	------

BB1	BB 20x40		2	3560
BB2	BB 20x40		2	5000

210628

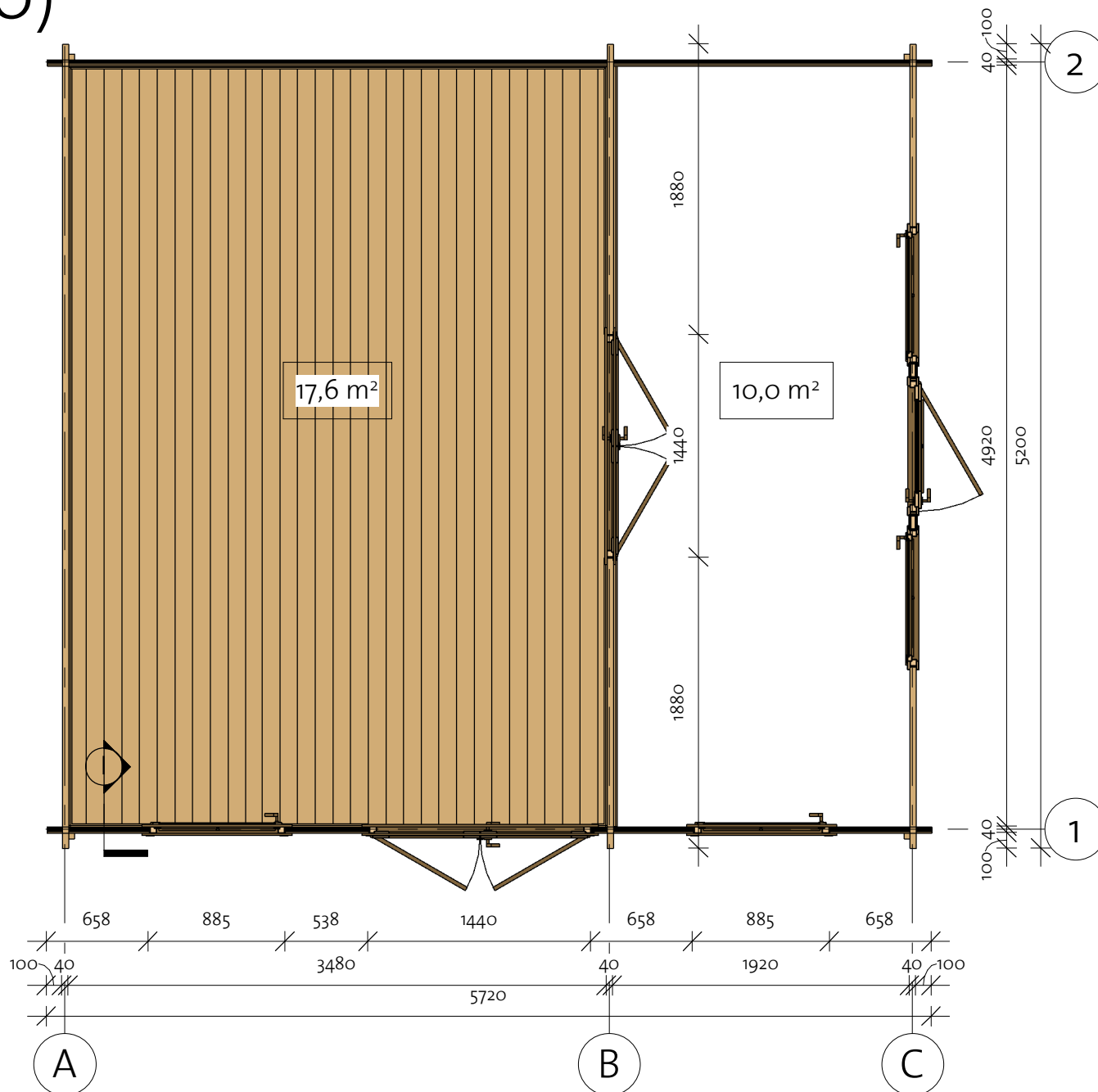

Luna 3 40 (552x500)

Wall 1

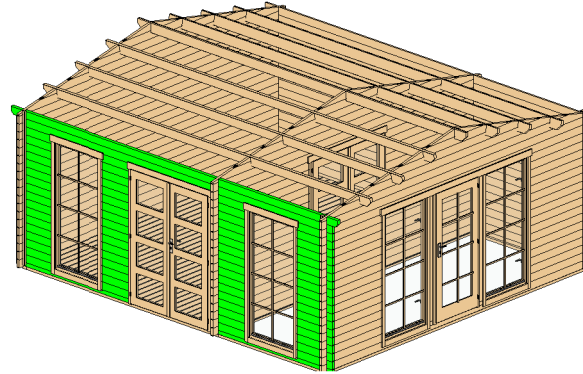

Wall 1			
Mark	Profile	Count	Cut Length

1BL-1	40X57	1	2200
1BL-2	40X57	1	2080
1LG-1	40X114	17	538
1LG-2	40X114	51	658
1LG-3	40X114	1	5720
1TL-1	40X114	1	5920

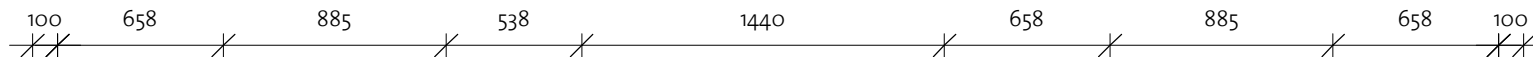
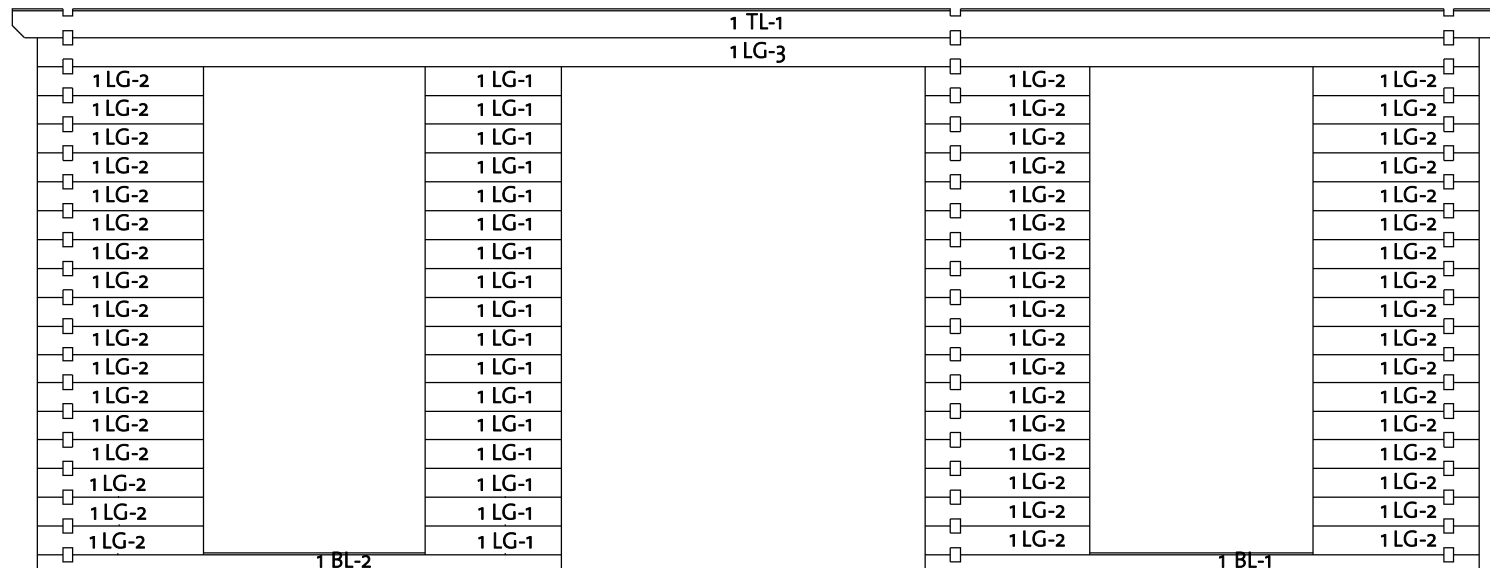

Log Profile Wall 1	
Profile	Profile

40X57	
40X114	
40X114	

Luna 3 40 (552x500)

Wall A

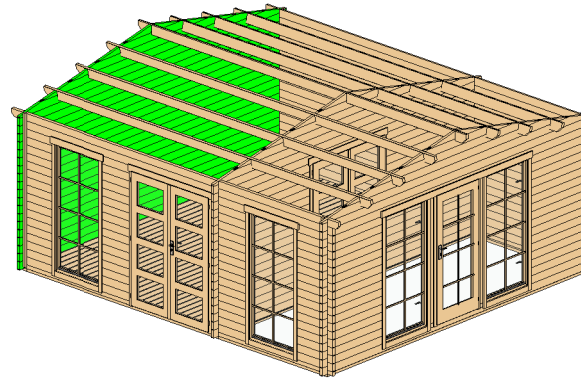

Wall A			
Mark	Profile	Count	Cut Length

ALG-1*	40x114	1	1095
ALG-2*	40x114	1	2188
ALG-3*	40x114	1	3281
ALG-4*	40x114	1	4374
ALG-5*	40x114	1	5200
ALG-6	40x114	19	5200

*Gable-delivered premounted

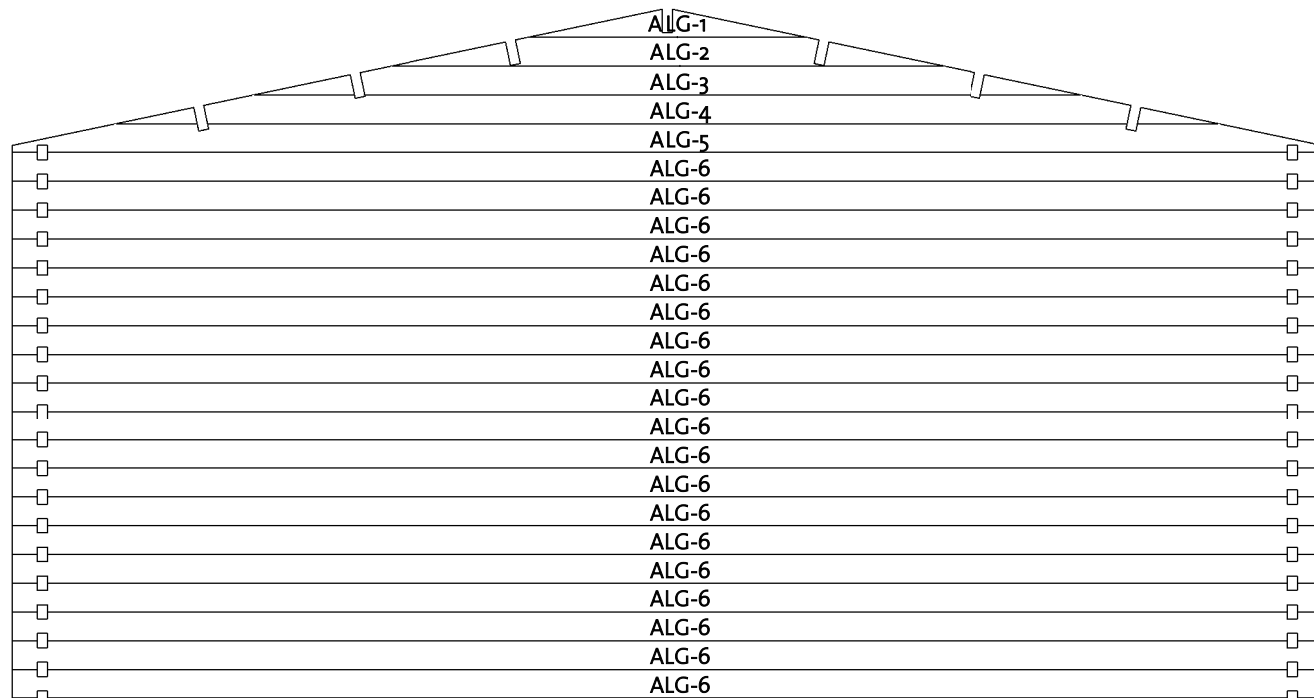

5200

Log Profile Wall A	
Profile	Profile

40x114	
--------	--

Luna 3 40 (552x500)

Wall B

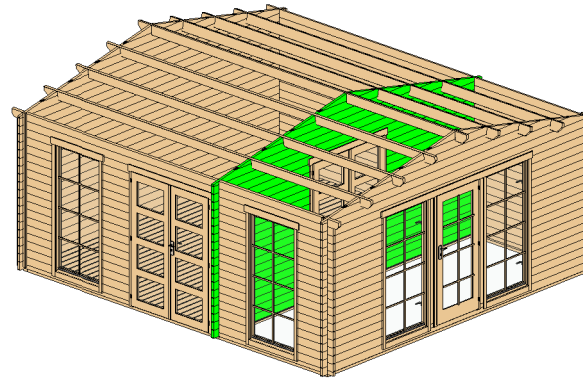

Wall B			
Mark	Profile	Count	Cut Length
BLG-1*	40x114	1	1095
BLG-2*	40x114	1	2188
BLG-3*	40x114	1	3281
BLG-4*	40x114	1	4374
BLG-5*	40x114	1	5200
BLG-6	40x114	1	5200
BLG-7	40x114	1	5200
BLG-8	40x114	34	1880

*Gable-delivered premounted

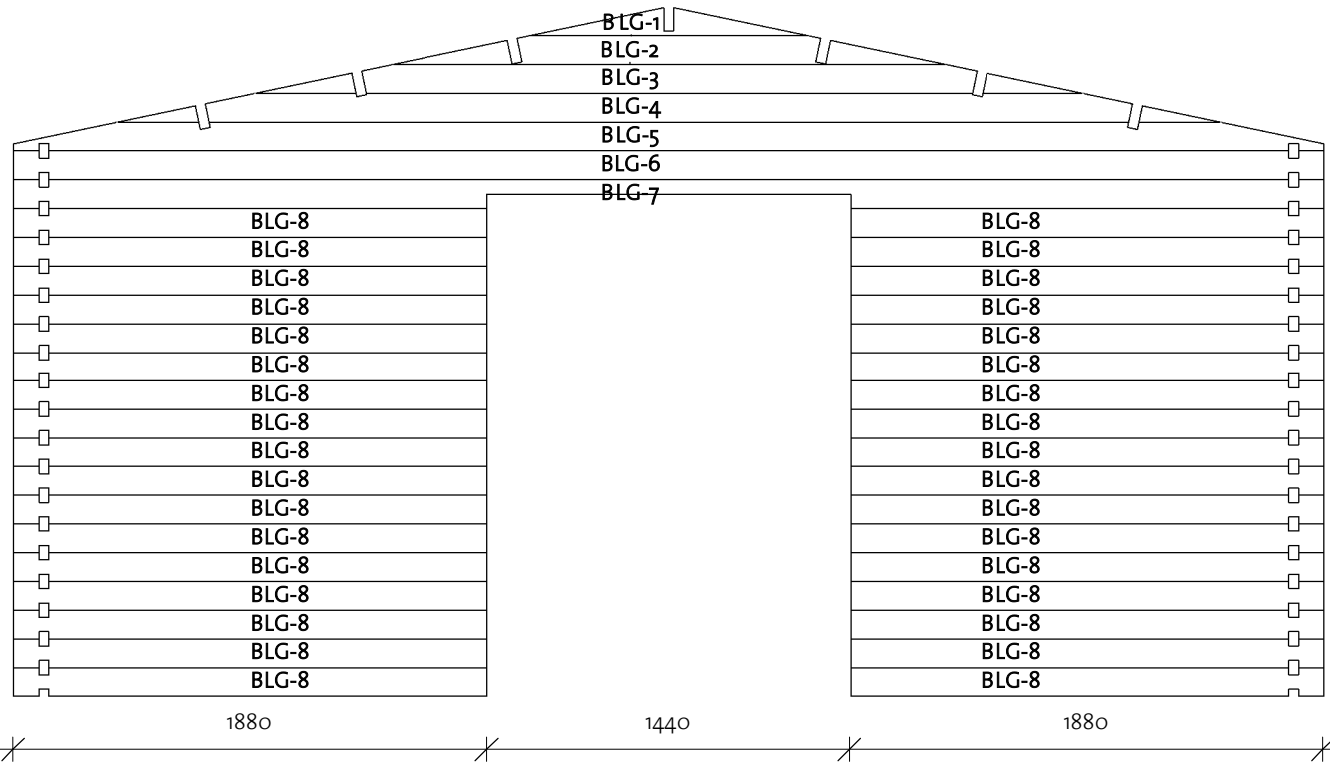

210628

Log Profile Wall B	
Profile	Profile
40x114	

Luna 3 40 (552x500)

Wall C

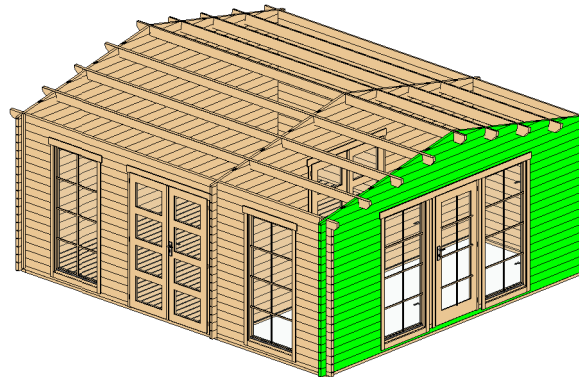

Wall C			
Mark	Profile	Count	Cut Length
CLG-1*	40x114	1	1095
CLG-2*	40x114	1	2188
CLG-3*	40x114	1	3281
CLG-4*	40x114	1	4374
CLG-5*	40x114	1	5200
CLG-6	40x114	1	5200
CLG-7	40x114	32	1179
CLG-8	40x114	1	5200
CLG-9	40x114	1	5200

*Gable-delivered premounted

Columns			
Mark	Profile	Count	Length
CM1	Post 40x94	2	1890

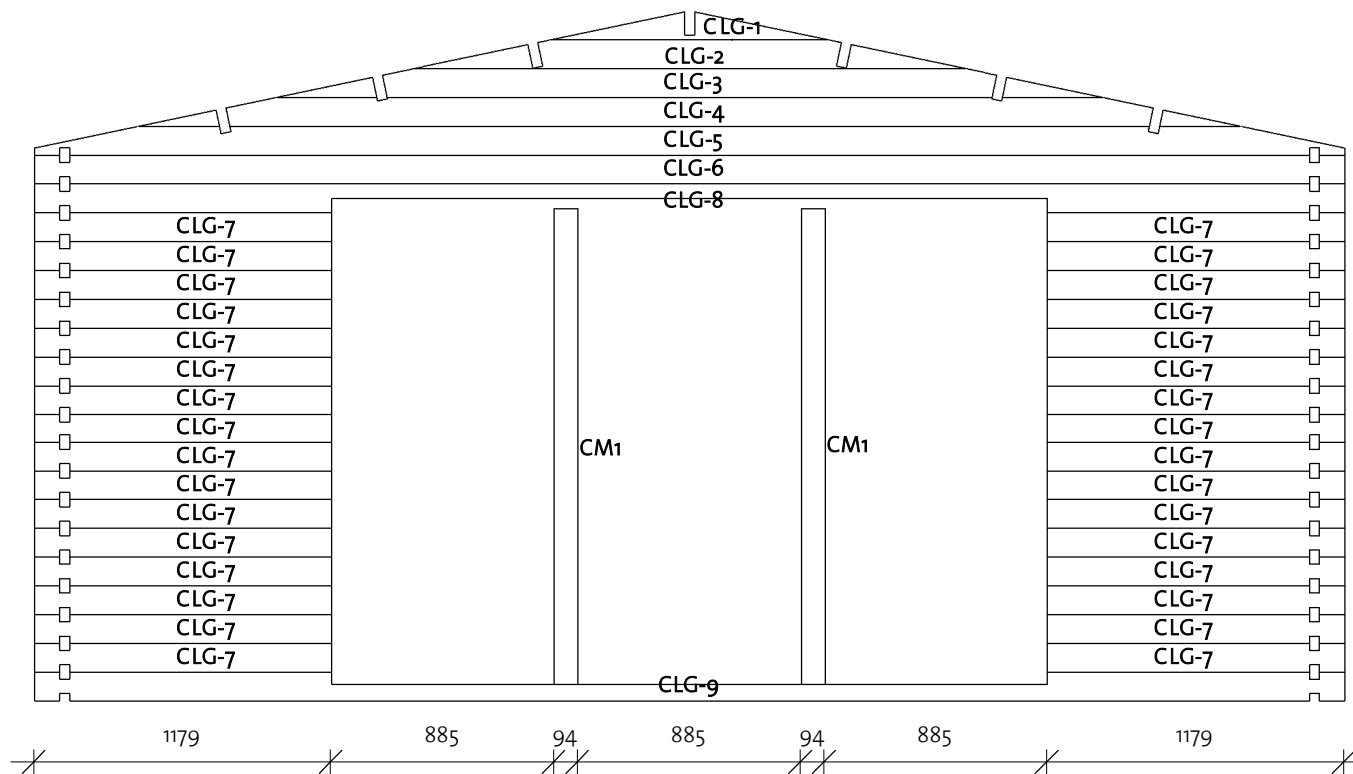
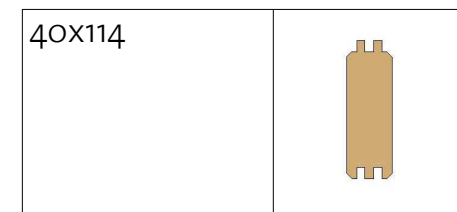

Log Profile Wall C	
Profile	Profile

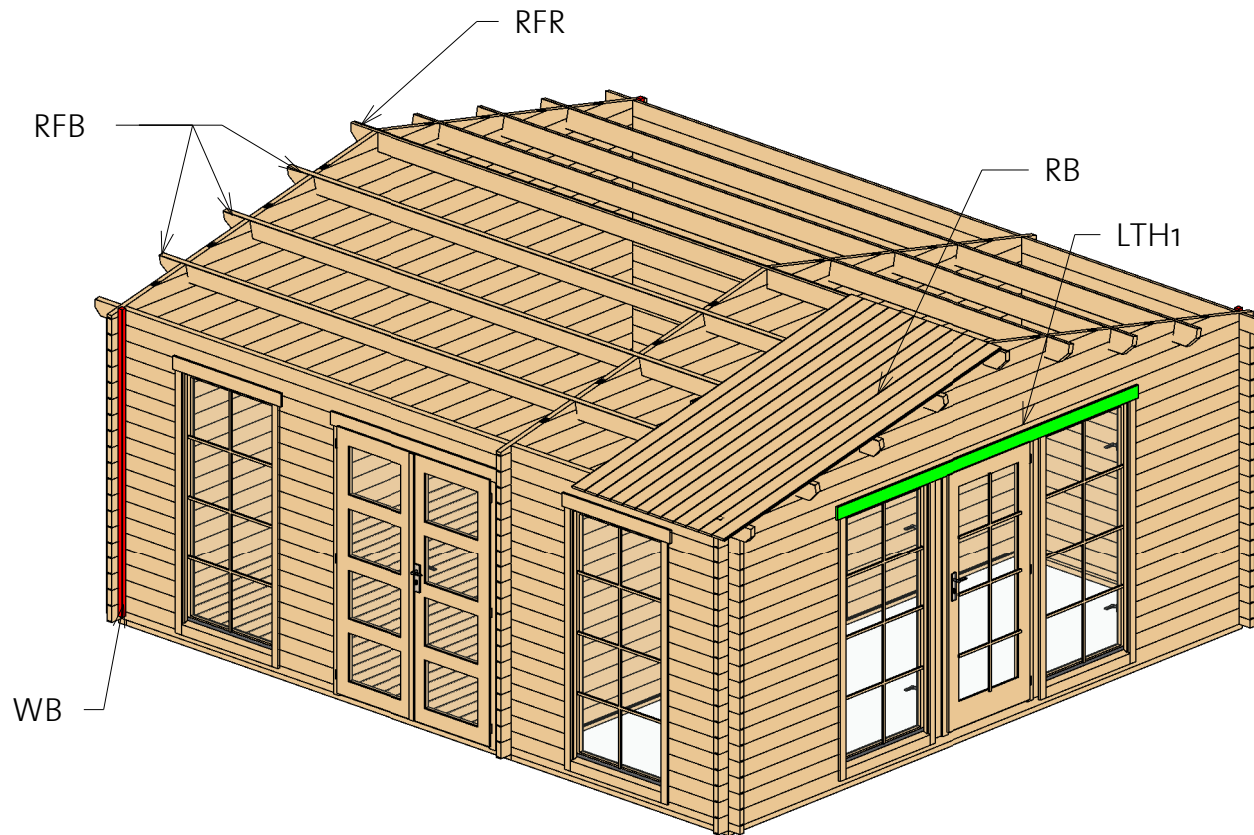

Luna 3 40 (552x500)

Roof 1



Roof				
Mark	Type	Profile	Count	Length
RFR	Ridge 40x143		1	5920
RFB	Beam 40x143		6	5920
RB	17x114		106	2754

Lath list				
Mark	Type	Profile	Count	Length
LTH1	18x95		2	2930

Luna 3 40 (552x500)

Roof 2

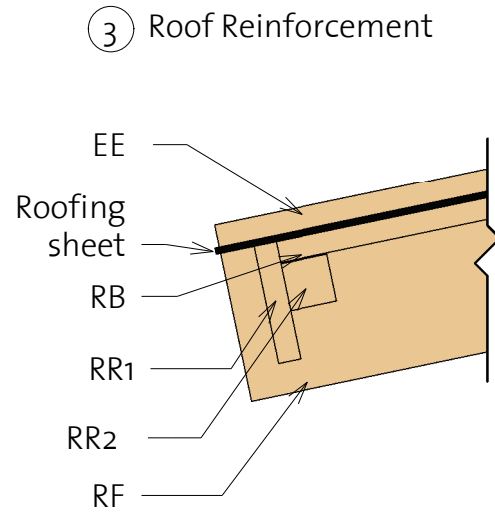
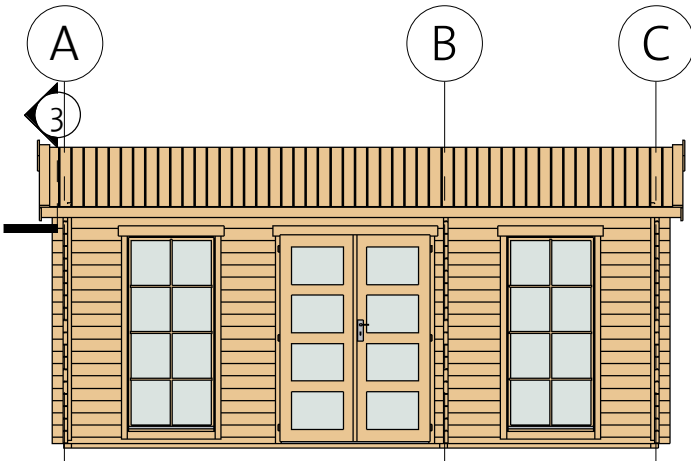
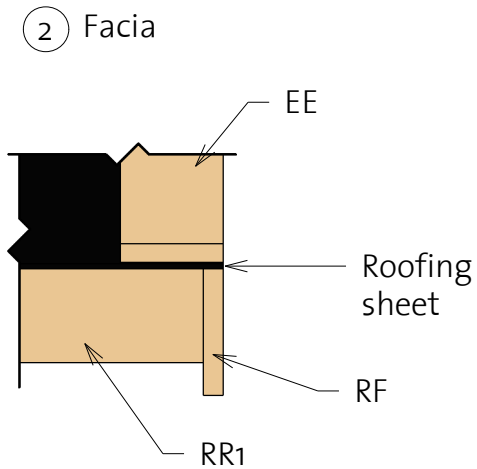
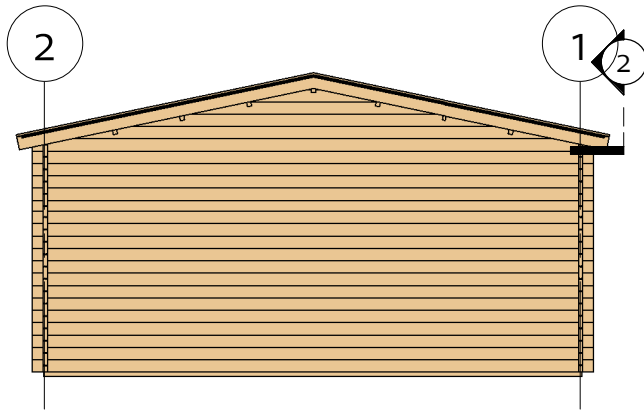

Fascia Schedule				
Mark	Type	Profile	Count	Length
EE	Eave Edging 18x95		4	2803
RF	Roof Fascia 18x120		4	2803
RR1	Roof reinforcement 18x95		2	5920
RR2	Roof reinforcement 38x38		2	5920

Luna 3 40 (552x500)

Extras

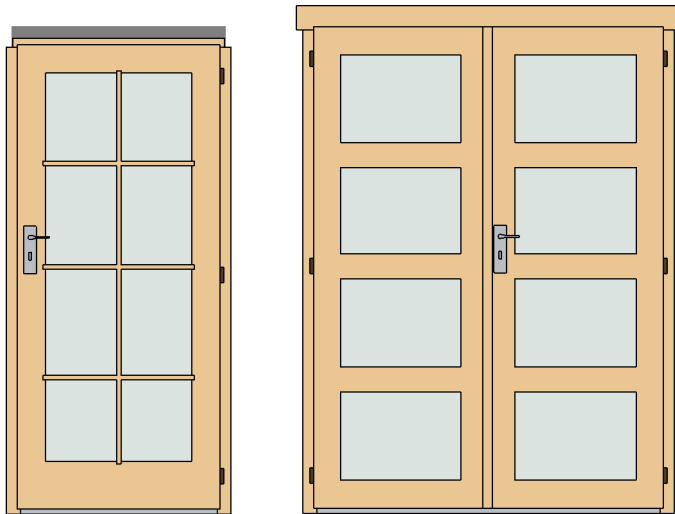

Door Schedule				
Mark	Type	Width	Height	Count
CD10R	Classic door 10 right	840	1890	1
CDD2R	Classic double door 2, four glass right	1425	1955	2

Fasteners & Extras		
Name	Type	Count

Hitblock	300-400 mm	
Screws	5,0 x 70	20
Bolts	M8 x 90	20
Nails	1,4 x 40	45
Screws	6,0 x 140	80
Screws	4,0 x 40	1050

Family	Count
Romb	2



Windboard		
Type	Count	Length
Windboard 38x38	4	2200

Luna 3 40 (552x500)

Extra 2

CW4R x 2

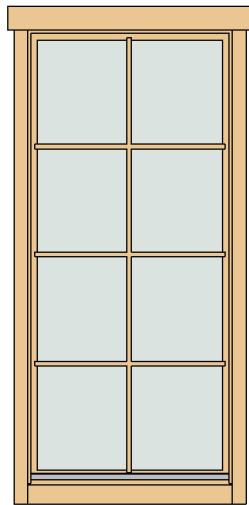

CW4R x 2

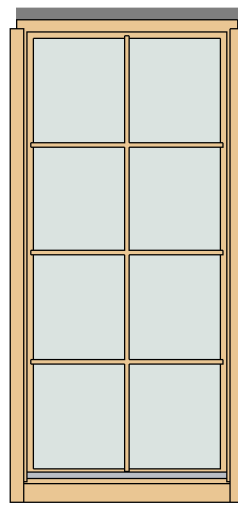

Window Schedule

Mark	Type	Width	Height	Count
CW4R	Classic window 4, right	875	1890	2
CW4R	Classic window 4, right	875	1890	2

WCB8-2	Windows Crossbar 8-2	--	--	4
--------	----------------------	----	----	---

- * Windows intended for tilt opening only!
- * Fenster zur Eröffnung nur zum Kippen vorgesehen!
- * Aknad on ette nähtud ainult kaldu avamiseks!



Luna 3 40 (552x500)

List of all items 1



Impregnated foundation beams

Mark	Type	Profile	Count	Length
IFB1	IFB 70x40		9	3410
IFB2	IFB 70x40		3	4990
IFB3	IFB 70x40		2	1890





Floor Schedule

Mark	Type	Profile	Count	Length
FB	FB 17x114		32	4914
BB1	BB 20x40		2	3560
BB2	BB 20x40		2	5000

Roof

Mark	Type	Profile	Count	Length
RFR	Ridge 40x143		1	5920
RFB	Beam 40x143		6	5920
RB	17x114		106	2754

Fascia Schedule

Mark	Type	Profile	Count	Length
EE	Eave Edging 18x95		4	2803
RF	Roof Fascia 18x120		4	2803
RR1	Roof reinforcement 18x95		2	5920
RR2	Roof reinforcement 38x38		2	5920

Luna 3 40 (552x500)

List of all items 2

Wall 1			
Mark	Profile	Count	Cut Length

1BL-1	40x57	1	2200
1BL-2	40x57	1	2080
1LG-1	40x114	17	538
1LG-2	40x114	51	658
1LG-3	40x114	1	5720
1TL-1	40x114	1	5920

Wall 2			
Mark	Profile	Count	Cut Length

2BL-1	40x57	1	5720
2LG-1	40x114	18	5720
2TL-1	40x114	1	5920



Lath list				
Mark	Type	Profile	Count	Length

LTH1	18x95		2	2930
------	-------	--	---	------

Columns			
Mark	Profile	Count	Length

CM1	Post 40x94	2	1890
-----	------------	---	------

Log Profiles	
Profile	Profile

40x57	
40x114	

Log Profiles	
Profile	Profile

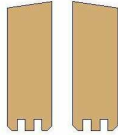
40x114	
--------	---

Luna 3 40 (552x500)

List of all items 3

Wall A			
Mark	Profile	Count	Cut Length

ALG-1*	40X114	1	1095
ALG-2*	40X114	1	2188
ALG-3*	40X114	1	3281
ALG-4*	40X114	1	4374
ALG-5*	40X114	1	5200
ALG-6	40X114	19	5200

Wall C			
Mark	Profile	Count	Cut Length

CLG-1*	40X114	1	1095
CLG-2*	40X114	1	2188
CLG-3*	40X114	1	3281
CLG-4*	40X114	1	4374
CLG-5*	40X114	1	5200
CLG-6	40X114	1	5200
CLG-7	40X114	32	1179
CLG-8	40X114	1	5200
CLG-9	40X114	1	5200

Log Profiles2	
Profile	Profile

40X114	
--------	---

Wall B			
Mark	Profile	Count	Cut Length

BLG-1*	40X114	1	1095
BLG-2*	40X114	1	2188
BLG-3*	40X114	1	3281
BLG-4*	40X114	1	4374
BLG-5*	40X114	1	5200
BLG-6	40X114	1	5200
BLG-7	40X114	1	5200
BLG-8	40X114	34	1880

*Gable-delivered premounted

Windboard

① Windboard Assembly 1



② Windboard Assembly 2

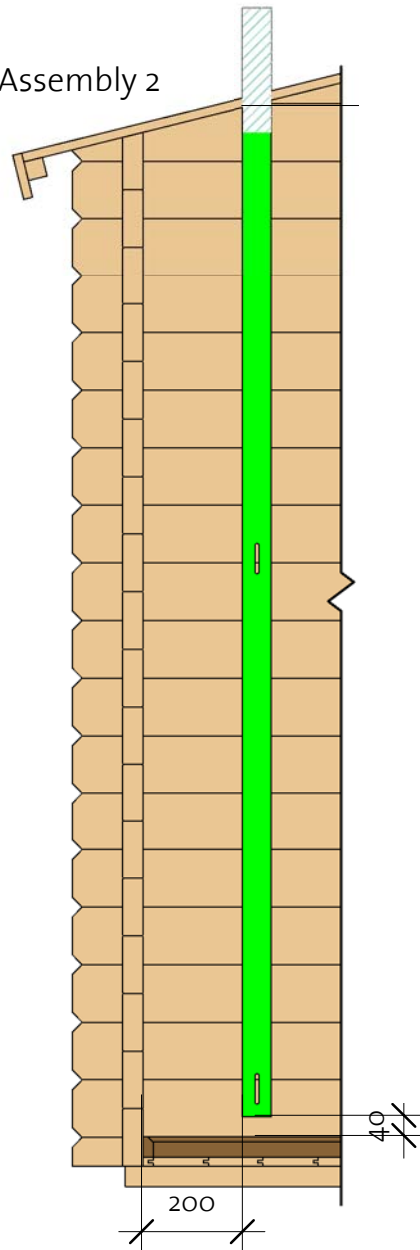

③ Windboard Assembly 3

